

This Add Bay is only supplied with one post as it attaches to an existing post on a Start Bay.

Rev	Date	Description

ALL DIMENSIONS IN (mm)
UNLESS OTHERWISE SPECIFIED
BREAK ALL SHARP EDGES

TOLERANCES
(BEFORE PAINTING
& AFTER PLATING)
X ± 1.00
X.X ± 0.50
X.XX ± 0.10
ANGLES ± 0.5°

A01- RENDER
CLIENT: RFA1000
PROJ. NO.: TBA
PART NO.: --
Revision --
Page 1

600mm(W)x1515mm(H)x270mm(D) DOUBLE SIDED GONDOLA BAY-PERFORATED TWCM - START BAY (PEARL WHITE)		
PRODUCT CODE: RFA1032	Date: 8/06/2023	
Drawn by	DH	DO NOT SCALE
Checked by	--	Scale@A3 1:20

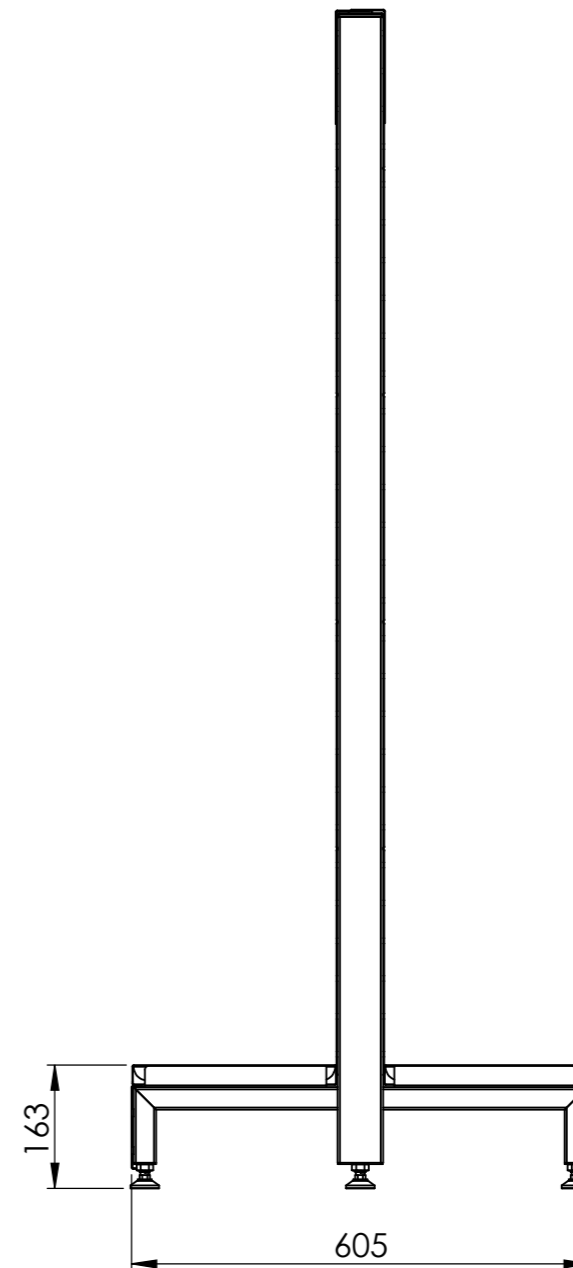
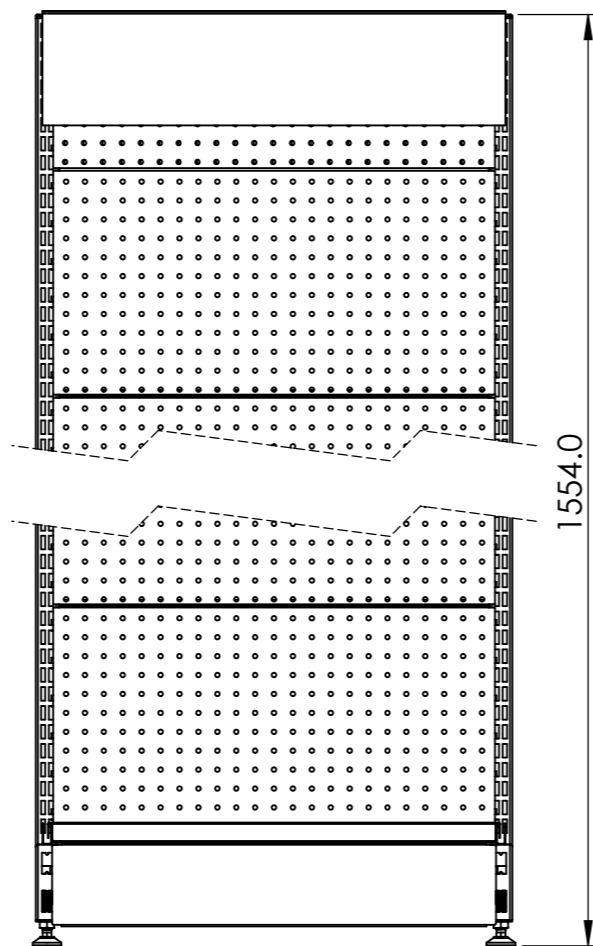
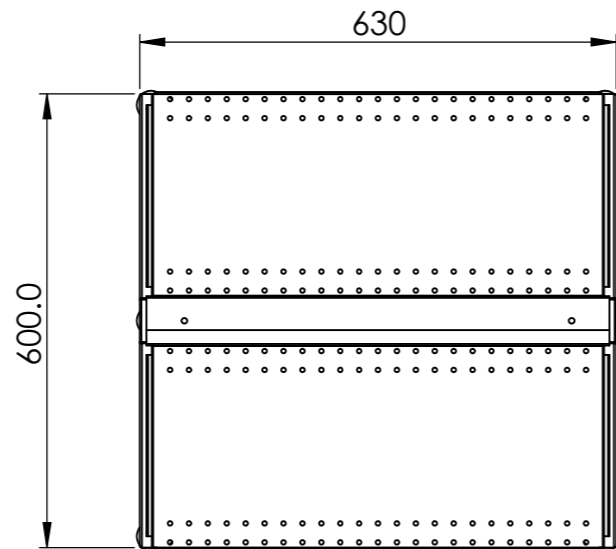
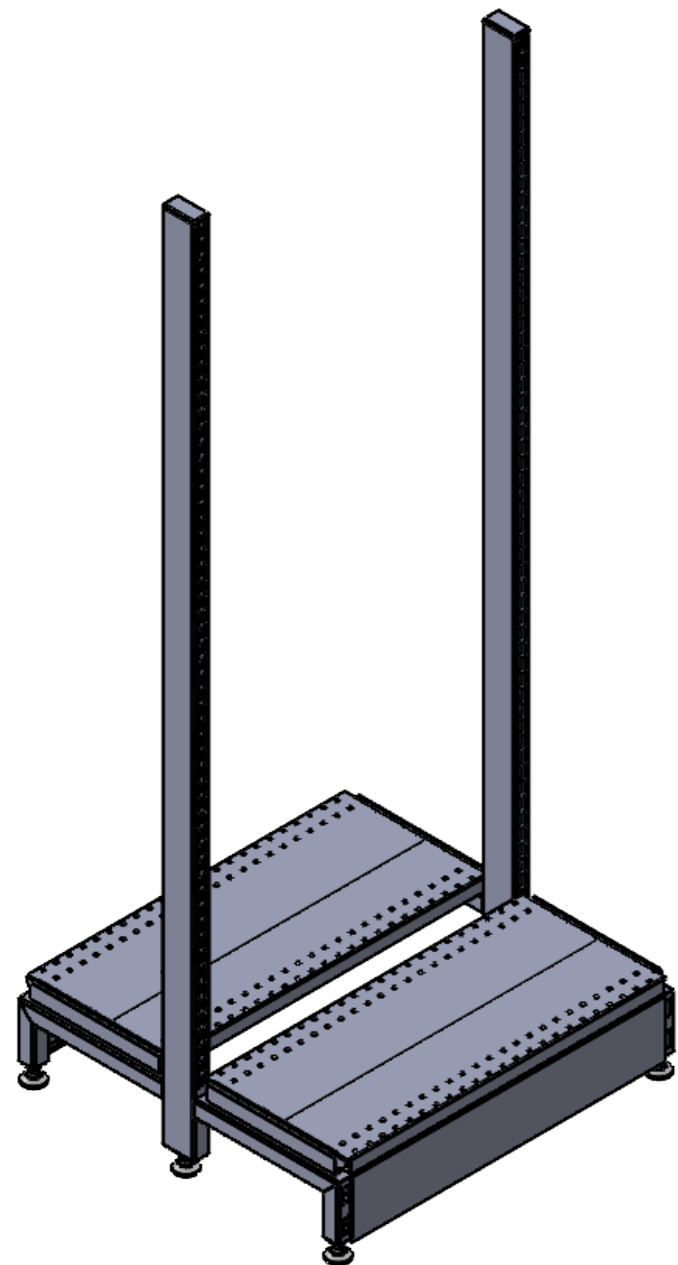

Rev	Date	Description

ALL DIMENSIONS IN (mm)
UNLESS OTHERWISE SPECIFIED
BREAK ALL SHARP EDGES

TOLERANCES
(BEFORE PAINTING
& AFTER PLATING)
X ± 1.00
X.X ± 0.50
X.XX ± 0.10
ANGLES ± 0.5°

A02- CLIENT
CLIENT: RFA1000
PROJ. NO.: TBA
PART NO.: --
Revision --
Page 2

600mm(W)x1515mm(H)x270mm(D)
DOUBLE SIDED GONDOLA BAY-PERFORATED
TWCM - START BAY (PEARL WHITE)

PRODUCT CODE: **RFA1032**

Date: 8/06/2023

Drawn by DH

Checked by --

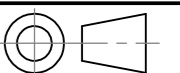

DO NOT SCALE

Scale@A3 1:15

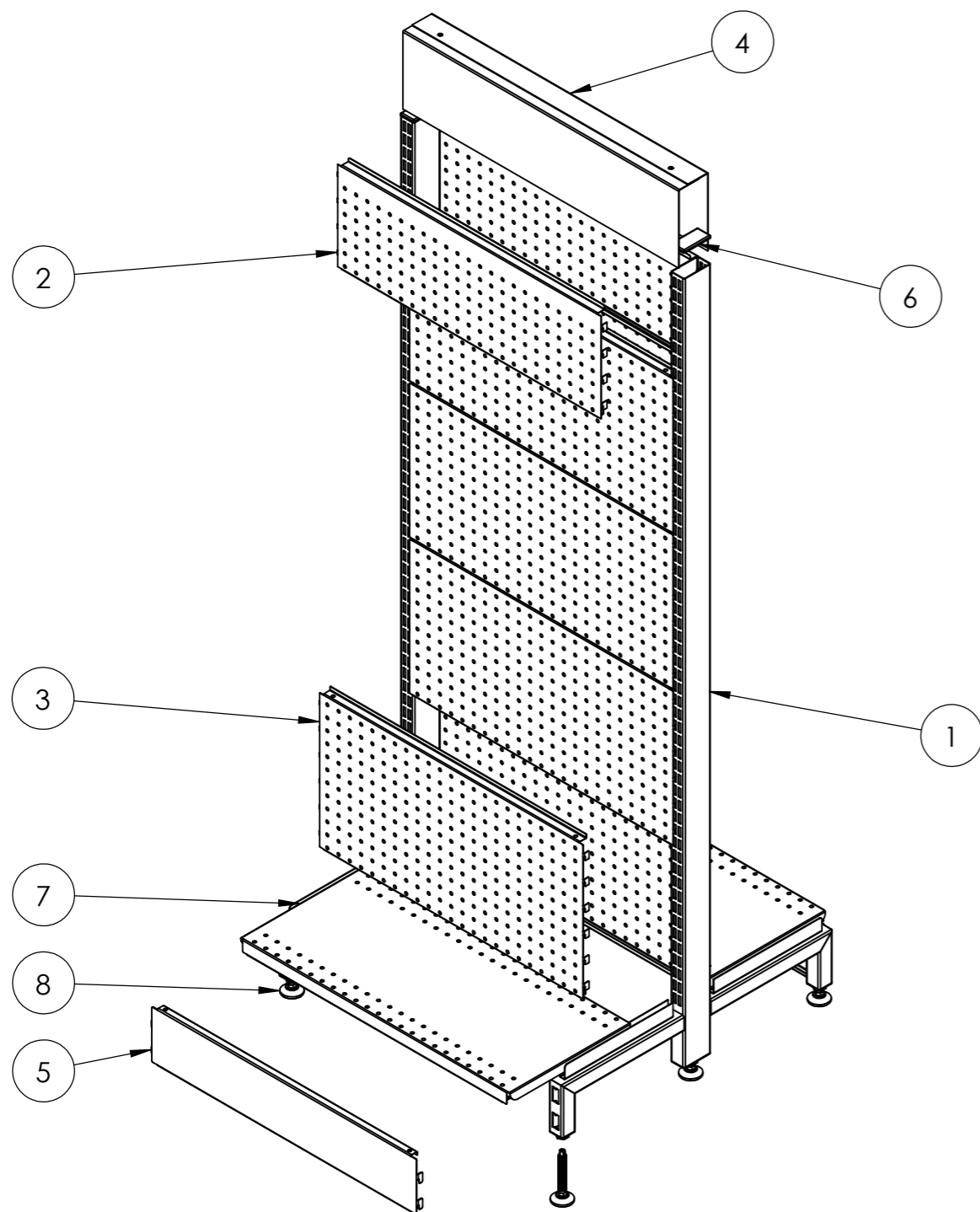

ITEM NO.	DESCRIPTION	QTY.
1	DOUBLE SIDED POST	1
2	600W X 200H PERF. PANEL	2
3	600W x 300H PERF PANEL	8
4	613X150 TOP COVER	1
5	BOTTOM SKIRT	2
6	PLASTIC ENDCAP	2
7	600X270 SHELF	2
8	M12 LEVELING FEET	6

This Add Bay is only supplied with one post as it attaches to an existing post on a Start Bay.

Rev	Date	Description

ALL DIMENSIONS IN (mm)
UNLESS OTHERWISE SPECIFIED
BREAK ALL SHARP EDGES

TOLERANCES
(BEFORE PAINTING
& AFTER PLATING)
X ± 1.00
X.X ± 0.50
X.XX ± 0.10
ANGLES ± 0.5°

A09- EXPLODED
CLIENT: RFA1000
PROJ. NO.: TBA
PART NO.: --
Revision --
Page 9

600mm(W)x1515mm(H)x270mm(D)
DOUBLE SIDED GONDOLA BAY-PERFORATED
TWCM - START BAY (PEARL WHITE)

PRODUCT CODE: **RFA1032**

Date: 8/06/2023

Drawn by DH

Checked by --

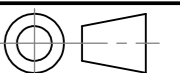

DO NOT SCALE

Scale@A3 1:20